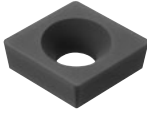
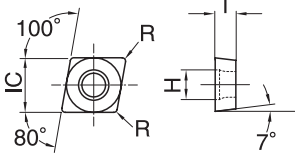
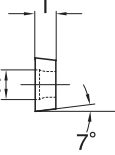

Stock List

● CCGW

	IC	T	H
CCGW21.5	1/4	3/32	.110
CCGW32.5	3/8	5/32	.173

  	R	Ceramics														
		Silicon-Nitride				SiAlON		Alumina		Alumina TiC			Whisker			
Insert Order Number	ISO Catalog Number		SX1	SX6	SX8	SP2	SX5	SX9	HC1	HW2	HC2	HC6	HC7	ZC4	ZC7	WA1
CCGW 21.51 T0225	CCGW 060204 T00525	1/64									●					
21.52 T0225	060208 T00525	1/32									●					
32.51 T0425	09T304 T01025	1/64									●					
32.52 T0425	09T308 T01025	1/32									●					

For details of boring bars, see page 168.

● : Stock ★ : 2 weeks delivery

● CDH

	IC	T	H
CDH22	1/2	1/4	.125
CDH33	3/4	3/8	.250

	IC	T	H
CDH42	1	1/2	.266
CDH43	1	3/4	.266

	IC	T	H
CDH515	1-1/4	3/8	.391
CDH53	1-1/4	3/4	.391

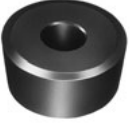
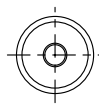
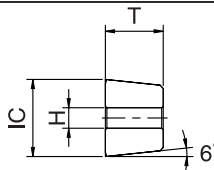
  	R	Ceramics														
		Silicon-Nitride				SiAlON		Alumina		Alumina TiC			Whisker			
Insert Order Number	ISO Catalog Number		SX1	SX6	SX8	SP2	SX5	SX9	HC1	HW2	HC2	HC6	HC7	ZC4	ZC7	WA1
CDH 22 P2810	CDH 1207 P07010										●		●			
33 Q6010	1909 Q15010										●					
42 P8015	2512 P20015										●					
	P12010G										●					
43 P6010	2519 P15010										●					
515 P7110B	3209 P18010B										●					
	P7110				●						●					
	P8015										●		●			
	Q7110										●					
53 P8015	3219 P20015										●			●		
	Q9515										●					
	Q24015										●					

For details of toolholders, see page 152.

● : Stock ★ : 2 weeks delivery

● CNG

	IC	T		IC	T		IC	T
CNG43	1/2	3/16	CNG54	5/8	1/4	CNG64	3/4	1/4
CNG45	1/2	5/16	CNG55	5/8	5/16	CNG65	3/4	5/16

Insert Order Number			ISO Catalog Number			R	Ceramics											
							Silicon-Nitride				SiAION	Alumina		Alumina TiC			Whisker	
							SX1	SX6	SX8	SP2	SX5	SX9	HC1	HW2	HC2	HC6	HC7	ZC4
CNG 431	T0525	CNGN 120404	T01225	1/64								●						
432	T0220	120408	T00520	1/32				●	●									●
	T0420		T01020	1/32														●
	T0425		T01025	1/32			★					★	●		★			
	T0525		T01225	1/32								●				●		
	T0820		T02020	1/32		★			★									
	T0825		T02025	1/32	●		●	●	★	★								
433	T0220	120412	T00520	3/64				●	●									●
	T0420		T01020	3/64					●	★								●
	T0425		T01025	3/64			★					★	●				★	
	T0525		T01225	3/64								●				●		
	T0820		T02020	3/64		★												
	T0825		T02025	3/64	●		●	●	★	★								
434	T0220	120416	T00520	1/16				●										●
	T0420		T01020	1/16					●									
	T0525		T01225	1/16								●						
	T0820		T02020	1/16		★												
	T0825		T02025	1/16	●		●		★	★								
452	T0220	120708	T00520	1/32														●
	T0825		T02025	1/32								●						
453	T0220	120712	T00520	3/64				●										●
	T0825		T02025	3/64	●		●	●				●						
454	T0220	120716	T00520	1/16														●
	T0825		T02025	1/16	●							●						
542	T0825	160608	T02025	1/32								●						
543	T0825	160612	T02025	3/64								●						
552	T0825	160708	T02025	1/32								●						
555	U1625	160720	U04025	5/64								●						
643	T0825	190612	T02025	3/64								●						
644	T0825	190616	T02025	1/16						●		●						
646	T0220	190624	T00520	3/32														●
648	T0825	190632	T02025	1/8								●						
656	T0220	190724	T00520	3/32				●										

For details of toolholders, see pages 116, 121 and 128.

● : Stock ★ : 2 weeks delivery

● CNGA

	IC	T	H
CNGA43	1/2	3/16	.203
CNGA54	5/8	1/4	.250
CNGA64	3/4	1/4	.312

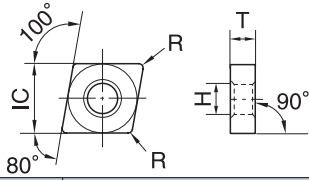
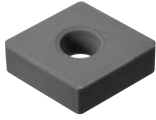

Insert Order Number	ISO Catalog Number	R	Ceramics													
			Silicon-Nitride			SiAlON	Alumina		Alumina TiC		Whisker					
			SX1	SX6	SX8	SP2	SX5	SX9	HC1	HW2	HC2	HC6	HC7	ZC4	ZC7	WA1
CNGA 431 S0825	CNGA 120404 S02025	1/64													●	
T0220	T00520	1/64														●
T0425	T01025	1/64			●						●				●	
T0525	T01225	1/64									●			●		
T0825	T02025	1/64	●													
Z0825	Z02025	1/64													●	
432 S0825	120408 S02025	1/32													●	
T0220	T00520	1/32					●	●								●
T0225	T00525	1/32				●										
T0420	T01020	1/32														●
T0425	T01025	1/32			★						★	★			●	
T0525	T01225	1/32							●		●	●		●		
T0820	T02020	1/32		●						●						
T0825	T02025	1/32	●		●	●		★								
Z0825	Z02025	1/32												●		
433 S0825	120412 S02025	3/64													●	
T0220	T00520	3/64					●	●								●
T0225	T00525	3/64				●										
T0420	T01020	3/64						●								●
T0425	T01025	3/64			★				★		★	★			●	
T0525	T01225	3/64							●		●	●		●		
T0820	T02020	3/64		●					●		●					
T0825	T02025	3/64	★		●						●					
Z0825	Z02025	3/64												●		
434 T0220	120416 T00520	1/16						●								●
T0420	T01020	1/16														●
T0525	T01225	1/16									●			●		
T0820	T02020	1/16		●												
T0825	T02025	1/16	●		●	●		★								
Z0825	Z02025	1/16												●		
542 T0825	160608 T02025	1/32									●					
543 T0220	160612 T00520	3/64						●								●
T0825	T02025	3/64	●		●	●					●					
Z0825	Z02025	3/64												●		
544 T0220	160616 T00520	1/16						●								●
T0825	T02025	1/16	●		●	●					●					
Z0825	Z02025	1/16												●		
642 T0825	190608 T02025	1/32			●						●					
643 T0220	190612 T00520	3/64						●								●
T0420	T01020	3/64														●
T0825	T02025	3/64	●		●	●					●					
644 T0220	190616 T00520	1/16						●								●
T0825	T02025	1/16	●								●					
648 T0825	190632 T02025	1/8	●		●											

For details of toolholders, see pages 121 and 128.

● : Stock ★ : 2 weeks delivery

● CNGA-WL with wiper for higher feed

	IC	T	H
CNGA43_WL	1/2	3/16	.203

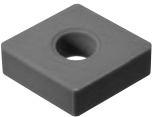
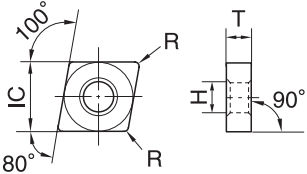
 	R	Ceramics													
		Silicon-Nitride		SiAION	Alumina		Alumina TiC			Whisker					
Insert Order Number	ISO Catalog Number	SX1	SX6	SX8	SP2	SX5	SX9	HC1	HW2	HC2	HC6	HC7	ZC4	ZC7	WA1
CNGA 432 WL T0425	CNGA 120408 WL T01025	1/32	●												★
433 WL T0425	120412 WL T01025	3/64	●												★
T0525	T01225	3/64											●		
434 WL T0225	120416 WL T00525	1/16	●												
T0425	T01025	1/16	●												

For details of toolholders, see pages 121 and 128.

● : Stock ★ : 2 weeks delivery

● CNGA-WLM with wiper for slower feed

	IC	T	H
CNGA43_WLM	1/2	3/16	.203

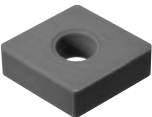
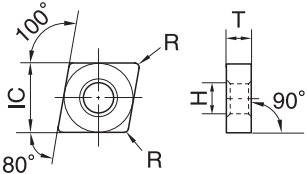
 	R	Ceramics													
		Silicon-Nitride		SiAION	Alumina		Alumina TiC			Whisker					
Insert Order Number	ISO Catalog Number	SX1	SX6	SX8	SP2	SX5	SX9	HC1	HW2	HC2	HC6	HC7	ZC4	ZC7	WA1
CNGA 432 WLM T0425	CNGA 120408 WLM T01025	1/32	●								●				
433 WLM T0425	120412 WLM T01025	3/64	●					●		●					

For details of toolholders, see pages 121 and 128.

● : Stock ★ : 2 weeks delivery

● CNGG with chip-breaker

	IC	T	H
CNGG43	1/2	3/16	.203

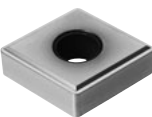
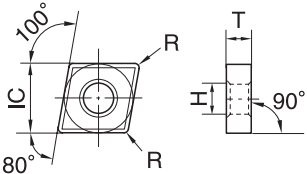
 	R	Ceramics													
		Silicon-Nitride		SiAION	Alumina		Alumina TiC			Whisker					
Insert Order Number	ISO Catalog Number	SX1	SX6	SX8	SP2	SX5	SX9	HC1	HW2	HC2	HC6	HC7	ZC4	ZC7	WA1
CNGG 432 Z0430 AG	CNGG 120408 Z01030 AG	1/32												●	
433 Z0430 AG	120412 Z01030 AG	3/64												●	

For details of toolholders, see pages 121 and 128.

● : Stock ★ : 2 weeks delivery

● CNGX

	IC	T
CNGX43	1/2	3/16
CNGX45	1/2	5/16

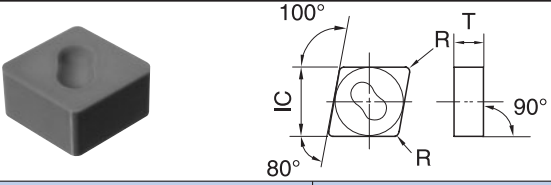

Insert Order Number		ISO Catalog Number		R	Ceramics													
					Silicon-Nitride				SiAlON		Alumina		Alumina TiC			Whisker		
					SX1	SX6	SX8	SP2	SX5	SX9	HC1	HW2	HC2	HC6	HC7	ZC4	ZC7	WA1
CNGX 432	T0420 DP5	CNGX 120408	T01020 DP5	1/32						●								
	T0820 DP5		T02020 DP5	1/32		●												
433	T0420 DP5	120412	T01020 DP5	3/64						●								
	T0820 DP5		T02020 DP5	3/64		●												
434	T0420 DP5	120416	T01020 DP5	1/16						●								
	T0820 DP5		T02020 DP5	1/16		●												
452	T0220 DP5	120708	T00520 DP5	1/32						●								
	T0820 DP5		T02020 DP5	1/32		●												
	T0825 DP5		T02025 DP5	1/32	●													
453	T0220 DP5	120712	T00520 DP5	3/64						●								
	T0420 DP5		T01020 DP5	3/64						●								
	T0820 DP5		T02020 DP5	3/64		●				●								
	T0825 DP5		T02025 DP5	3/64	●						●							
454	S0825 DP5	120716	S02025 DP5	1/16	●													
	T0420 DP5		T01020 DP5	1/16						●								
	T0425 DP5		T01025 DP5	1/16	●													
	T0820 DP5		T02020 DP5	1/16		●				●								
	T0825 DP5		T02025 DP5	1/16	●													

For details of toolholders, see pages 116, 121 and 128.

● : Stock ★ : 2 weeks delivery

● DNG

	IC	T
DNG43	1/2	3/16
DNG45	1/2	5/16
DNG54	5/8	1/4

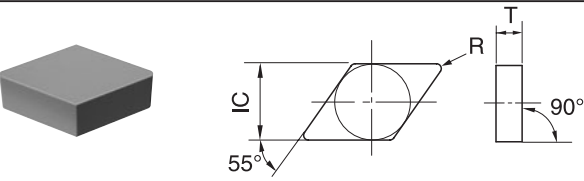

Insert Order Number		ISO Catalog Number		R	Ceramics													
					Silicon-Nitride				SiAlON		Alumina		Alumina TiC			Whisker		
					SX1	SX6	SX8	SP2	SX5	SX9	HC1	HW2	HC2	HC6	HC7	ZC4	ZC7	WA1
DNG 432	T0220	DNGN 150408	T00520	1/32														●
	T0420		T01020	1/32														●
	T0425		T01025	1/32													★	
	T0525		T01225	1/32														
433	T0220	150412	T00520	3/64								●						●
	T0420		T01020	3/64														●
	T0425		T01025	3/64														
	T0625		T01525	3/64									●					
	T0820		T02020	3/64			★						●					
	T0825		T02025	3/64	★													
434	T0220	150416	T00520	1/16														●
	T0420		T01020	1/16														●
	T0425		T01025	1/16							●							
453	T0825	150712	T02025	3/64														●
454	T0825	150716	T02025	1/16							●							●
543	T0825	190612	T02025	3/64														●

For details of toolholders, see pages 122, 123 and 128.

● : Stock ★ : 2 weeks delivery

● DNGA

	IC	T	H
DNGA43	1/2	3/16	.203
DNGA44	1/2	1/4	.203
DNGA54	5/8	1/4	.250

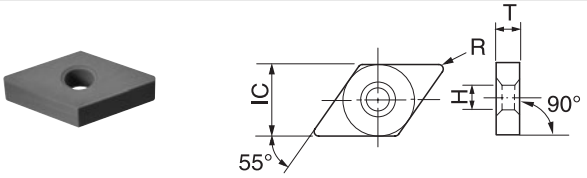
		Ceramics												
		Silicon-Nitride				SiAION		Alumina		Alumina TiC			Whisker	
		SX1	SX6	SX8	SP2	SX5	SX9	HC1	HW2	HC2	HC6	HC7	ZC4	ZC7
Insert Order Number	ISO Catalog Number	R												
DNGA 431 S0825	DNGA 150404 S02025	1/64											●	
T0220	T00520	1/64											●	
T0425	T01025	1/64							●	★			★	
T0525	T01225	1/64										●		
Z0825	Z02025	1/64										●		
432 S0825	150408 S02025	1/32											●	
T0220	T00520	1/32				●								●
T0420	T01020	1/32												●
T0425	T01025	1/32							★	★	★		●	
T0525	T01225	1/32							●	●	●		●	
T0820	T02020	1/32		★						●				
T0825	T02025	1/32	●		●	●		★						
Z0825	Z02025	1/32											●	
433 S0825	150412 S02025	3/64											●	
T0220	T00520	3/64				●	●							●
T0420	T01020	3/64												●
T0425	T01025	3/64							★				★	
T0525	T01225	3/64								●	●			
T0820	T02020	3/64		●						●				
T0825	T02025	3/64	★		●				●					
Z0825	Z02025	3/64											●	
434 S0820	150416 S02020	1/16												
T0220	T00520	1/16												●
T0420	T01020	1/16												●
436 T0220	150424 T00520	3/32												●
T0420	T01020	3/32												●
442 T0825	150608 T02025	1/32								●				
443 T0825	150612 T02025	3/64		●										
542 T0820	190608 T02020	1/32								●				
543 T0820	190612 T02020	3/64								●				
544 T0825	190616 T02025	1/16								●				

For details of toolholders, see pages 122, 123 and 128.

● : Stock ★ : 2 weeks delivery

● DNGG with chip-breaker

	IC	T	H
DNGG43	1/2	3/16	.203

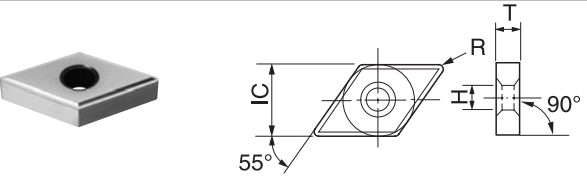
		Ceramics												
		Silicon-Nitride				SiAION		Alumina		Alumina TiC			Whisker	
		SX1	SX6	SX8	SP2	SX5	SX9	HC1	HW2	HC2	HC6	HC7	ZC4	ZC7
Insert Order Number	ISO Catalog Number	R												
DNGG 432 Z0430 AG	DNGG 150408 Z01030 AG	1/32											●	
433 Z0430 AG	150412 Z01030 AG	3/64											★	

For details of toolholders, see pages 122, 123 and 128.

● : Stock ★ : 2 weeks delivery

● DNGX

	IC	T
DNGX1207	.394	5/16
DNGX45	1/2	5/16

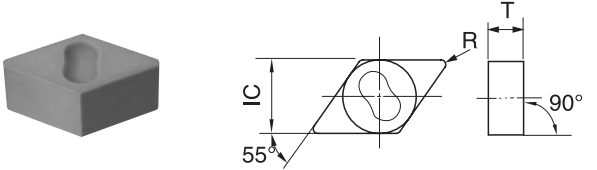

Insert Order Number		ISO Catalog Number		R	Ceramics										
					Silicon-Nitride				SiAlON	Alumina	Alumina TiC			Whisker	
SX1	SX6	SX8	SP2	SX5	SX9	HC1	HW2	HC2	HC6	HC7	ZC4	ZC7	WA1		
DNGX 120712	T0820 DP5	DNGX 120712	T02020 DP5	3/64	●										
	T0825 DP5		T02025 DP5	3/64				●							
120716	T0825 DP5	120716	T02025 DP5	1/16	●										
452	T0825 DP5	150708	T02025 DP5	1/32	●										
453	T0825 DP5	150712	T02025 DP5	3/64	●										
454	T0825 DP5	150716	T02025 DP5	1/16	●										

For details of toolholders, see pages 122 and 123.

● : Stock ★ : 2 weeks delivery

● GKN

	W	D		W	D
GKN3062	.062	.094	GKN3156	.156	.150
GKN3094	.094	.150	GKN3189	.189	.150
GKN3125	.125	.150			

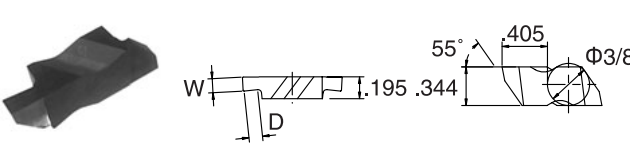

Insert Order Number		ISO Catalog Number		R	Ceramics										
					Silicon-Nitride				SiAlON	Alumina	Alumina TiC			Whisker	
SX1	SX2	SX6	SX8	SP2	SX5	SX9	HC1	HW2	HC2	HC6	HC7	ZC4	ZC7	WA1	
GKN 3062L		GKN 3062L		.008					●			●			
3062R		3062R		.008					●			●			
3094L		3094L		.008					●			●			
3094R		3094R		.008					●			●			
3125L		3125L		.012	●				●			●			
3125R		3125R		.012	●				●			●			
3156L		3156L		.012					●						
3156R		3156R		.012					●						
3189L		3189L		.012	●				●						
3189R		3189R		.012	●				●						

For details of toolholders, see page 140.

● : Stock ★ : 2 weeks delivery

● LNJ/LNM

	W	L	T
LNJ5464	5/8	1	3/8
LNJ6688	3/4	1-1/2	1/2

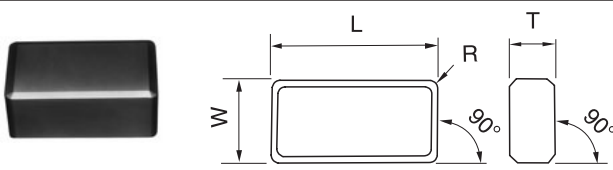

Insert Order Number		ISO Catalog Number		R	Ceramics										
					Silicon-Nitride				SiAlON	Alumina	Alumina TiC			Whisker	
SX1	SX6	SX8	SP2	SX5	SX9	HC1	HW2	HC2	HC6	HC7	ZC4	ZC7	WA1		
LNJ 5464	Q6015	LNJ 5464	Q15015	1/16					●						
6688	P6015	6688	P15015	1/8			●		●						
	Q8015		Q20015	1/8							●				

● : Stock ★ : 2 weeks delivery

● LNX with chip-breaker

	W	L	T
LNX324	3/8	5/8	1/4

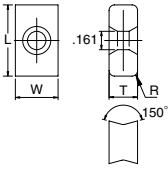
		R	Ceramics													
			Silicon-nitride				SiAlON	Alumina		Alumina TiC			Whisker			
Insert Order Number	ISO Catalog Number		SX1	SX6	SX8	SP2	SX5	SX9	HC1	HW2	HC2	HC6	HC7	ZC4	ZC7	WA1
LNX 324-02 T0420		1/32	●													
324-03 T0420		3/64	●													
324-04 T0420		1/16	●													

For details of milling cutters, see page 161.

● : Stock ★ : 2 weeks delivery

● RCGX10

	IC	T	θ		IC	T	θ
RCGX101	3/16	.240	90	RCGX105	5/8	.388	120
RCGX102	1/4	.309	120	RCGX106	3/4	.388	120
RCGX103	3/8	.309	120	RCGX108	1	.461	140
RCGX104	1/2	.312	120				

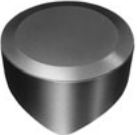
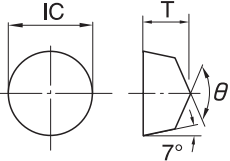
		R	Ceramics														
			Silicon-Nitride				SiAlON	Alumina		Alumina TiC			Whisker				
Insert Order Number	ISO Catalog Number		SX1	SX2	SX6	SX8	SP2	SX5	SX9	HC1	HW2	HC2	HC6	HC7	ZC4	ZC7	WA1
RCGX 101 P2010												●					
102 P4815												●					
T0820												●					
103 P4815												●					
P8015												●		●			
T0820												●					
T0825												●					
T1625												●					
104 P6015												●					
S8020												●					
T0820												●					
T1625												●					
105 P4815												●					
P8015												●		●			
S8020												●					
106 P4815												●					
P8015												●		●			
108 P8015												●					

For details of toolholders, see pages 149 and 150.

● : Stock ★ : 2 weeks delivery

● RCGX

	IC	T	θ
RCGX23	1/4	3/16	120
RCGX25	1/4	5/16	120
RCGX35	3/8	5/16	120
RCGX45	1/2	5/16	120

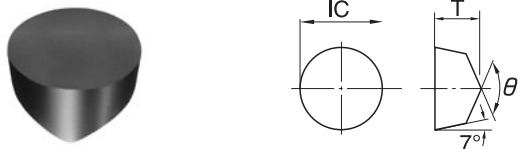
		R	Ceramics												
			Silicon-Nitride		SiAlON		Alumina		Alumina TiC			Whisker			
			SX1	SX6	SX8	SP2	SX5	SX9	HC1	HW2	HC2	HC6	HC7	ZC4	ZC7
Insert Order Number	ISO Catalog Number														
RCGX 23 T0220	RCGX 060400 T00520				●									●	
25 T0220	060700 T00520				●									●	
35 E02	090700 E004													●	
T0220	T00520				●	●								●	
T0420	T01020					●								●	
45 E02	120700 E004													●	
T0220	T00520				●	●								●	
T0420	T01020					●								●	
Z0620	Z01520													●	

For details of toolholders, see pages 148 - 150.

● : Stock ★ : 2 weeks delivery

● RKN

	W	D		W	D
RKN3078	.078	.150	RKN3156	.156	.150
RKN3094	.094	.150	RKN3189	.189	.150
RKN3125	.125	.150			

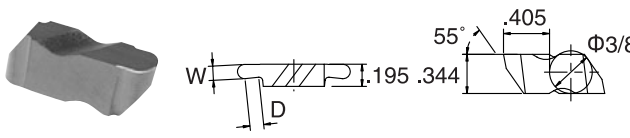
		R	Ceramics												
			Silicon-Nitride		SiAlON		Alumina		Alumina TiC			Whisker			
			SX1	SX6	SX8	SP2	SX5	SX9	HC1	HW2	HC2	HC6	HC7	ZC4	ZC7
Insert Order Number	ISO Catalog Number														
RKN 3078L	RKN 3078L	.039											●		
3078R	3078R	.039											●		
3094L	3094L	.047											●		
3094R	3094R	.047											●		
3125L	3125L	.063											●		
3125R	3125R	.063											●		
3156L	3156L	.078											●		
3156R	3156R	.078											●		
3189L	3189L	.095											●		
3189R	3189R	.095											●		

For details of toolholders, see page 140.

● : Stock ★ : 2 weeks delivery

RNG

	IC	T		IC	T		IC	T
RNG32	3/8	1/8	RNG44	1/2	1/4	RNG65	1	5/16
RNG33	3/8	3/16	RNG45	1/2	5/16	RNG85	1	5/16
RNG42	1/2	1/8	RNG55	5/8	5/16	RNG86	1	3/8
RNG43	1/2	3/16	RNG64	3/4	1/4			

		Ceramics															
		Silicon-Nitride				SiAlON		Alumina		Alumina TiC			Whisker				
		SX1	SX6	SX8	SP2	SX5	SX9	HC1	HW2	HC2	HC6	HC7	ZC4	ZC7	WA1		
Insert Order Number		ISO Catalog Number		R													
RNG 32	T0425	RNGN 090300	T01025														
	T0525		T01225						●								
33	T0825	090400	T02025						●					●			
42	T0425	120300	T01025						●								
43	S0825	120400	S02025												●		
	T0220		T00520				●	●									●
	T0420		T01020					●									●
	T0425		T01025							●				★			
	T0525		T01225						●								
	T0820		T02020														
	T0825		T02025	●		●	●	★									
	T2820		T07020						●								
	Z0825		Z02025									●	●				
45	E01	120700	E002				●										●
	P2810		P07010						●								
	S0825		S02025												●		
	T0220		T00520				●	●									●
	T0420		T01020				●	●				●					●
	T0825		T02025	●		●				●				★			
	Z0620		Z01520														●
	Z0825		Z02025									●	●				
55	T0220	150700	T00520				●	●									●
64	P6010	190600	P15010							●							
	T0220		T00520					●									
65	T0220	190700	T00520				●	●									●
	T0420		T01020					●									●
85	P2815	250700	P07015							●							
	S6015		S15015				●										
	T0220		T00520				●										
86	T0220	250900	T00520				●										

For details of toolholders, see page 116.

● : Stock ★ : 2 weeks delivery

● RPG

	IC	T		IC	T
RPG21.5	1/4	3/32	RPG43	1/2	3/16
RPG32	3/8	1/8	RPG65	3/4	5/16
RPG42	1/2	1/8			

Insert Order Number		ISO Catalog Number		R	Ceramics												
					Silicon-Nitride				SiAlON		Alumina		Alumina TiC			Whisker	
SX1	SX6	SX8	SP2		SX5	SX9	HC1	HW2	HC2	HC6	HC7	ZC4	ZC7	WA1			
RPG 21.5	T0220	RPGN 060200	T00520											●			
32	T0220	090300	T00520											●			
	T0425		T01025														
42	T0525	120300	T01225						●								
43	E01	120400	E002										●				
	T0220		T00520											●			
	T0420		T01020											●			
	Z0620		Z01520											●			
	Z0825		Z02025														
65	T0220	190700	T00520														

For details of milling cutters, see pages 162 and 163.

● : Stock ★ : 2 weeks delivery

● RPGX

	IC	T	θ
RPGX23	1/4	3/16	120
RPGX35	3/8	5/16	120
RPGX45	1/2	5/16	120

Insert Order Number		ISO Catalog Number		R	Ceramics												
					Silicon-Nitride				SiAlON		Alumina		Alumina TiC			Whisker	
SX1	SX6	SX8	SP2		SX5	SX9	HC1	HW2	HC2	HC6	HC7	ZC4	ZC7	WA1			
RPGX 23	T0220	RPGX 060400	T00520											●			
35	E02	090700	E004											●			
	T0220		T00520											●			
	T0420		T01020											●			
45	E02	120700	E004											●			
	T0220		T00520											●			
	T0420		T01020											●			

For details of toolholders, see pages 148 - 150.

● : Stock ★ : 2 weeks delivery

● SCG

	IC	T
SCG33	3/8	3/16
SCG43	1/2	3/16

Insert Order Number		ISO Catalog Number		R	Ceramics												
					Silicon-Nitride				SiAlON		Alumina		Alumina TiC			Whisker	
SX1	SX6	SX8	SP2		SX5	SX9	HC1	HW2	HC2	HC6	HC7	ZC4	ZC7	WA1			
SCG 333	T0425	SCGN 090412	T01025	3/64	●												
433	T0425	120412	T01025	3/64	●												

● : Stock ★ : 2 weeks delivery

● SDCW

	IC	T	H
SDCW43	1/2	3/16	.216

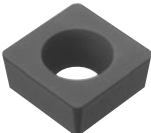
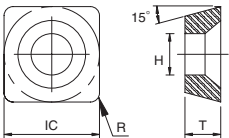
 	R	Ceramics													
		Silicon-Nitride				SiAION	Alumina		Alumina TiC			Whisker			
		SX1	SX6	SX8	SP2	SX5	SX9	HC1	HW2	HC2	HC6	HC7	ZC4	ZC7	WA1
Insert Order Number	ISO Catalog Number														
SDCW 432 T0420	SDCW 120408 T01020	1/32	●	●	●										
433 T0420	120412 T01020	3/64	●	●	●										
434 T0420	120416 T01020	1/16	●	●	●										

For details of milling cutters, see pages 155 - 157.

● : Stock ★ : 2 weeks delivery

● SDCW-AE with wiper for lead angle 45°

	IC	T	H
SDCW43AE	1/2	3/16	.216

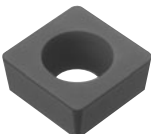
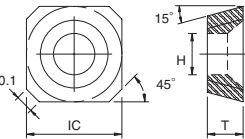
 	R	Ceramics													
		Silicon-Nitride				SiAION	Alumina		Alumina TiC			Whisker			
		SX1	SX6	SX8	SP2	SX5	SX9	HC1	HW2	HC2	HC6	HC7	ZC4	ZC7	WA1
Insert Order Number	ISO Catalog Number														
SDCW 43 AE T0420	SDCW 1204 AE T01020		●	●	●										

For details of milling cutters, see page 157.

● : Stock ★ : 2 weeks delivery

● SDCW-EE with wiper for lead angle 75°

	IC	T	H
SDCW43EE	1/2	3/16	.216

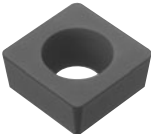
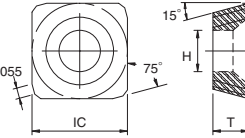
 	R	Ceramics													
		Silicon-Nitride				SiAION	Alumina		Alumina TiC			Whisker			
		SX1	SX6	SX8	SP2	SX5	SX9	HC1	HW2	HC2	HC6	HC7	ZC4	ZC7	WA1
Insert Order Number	ISO Catalog Number														
SDCW 43 EE T0420R	SDCW 1204 EE T01020R		●	●	●										

For details of milling cutters, see page 156.

● : Stock ★ : 2 weeks delivery

● SDCW-PE with wiper for lead angle 88°

	IC	T	H
SDCW43PE	1/2	3/16	.216

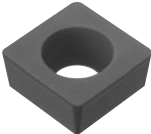
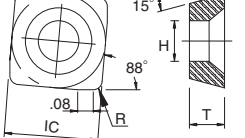
 	R	Ceramics													
		Silicon-Nitride				SiAION	Alumina		Alumina TiC			Whisker			
		SX1	SX6	SX8	SP2	SX5	SX9	HC1	HW2	HC2	HC6	HC7	ZC4	ZC7	WA1
Insert Order Number	ISO Catalog Number														
SDCW 43 PE T0420R	SDCW 1204 PE T01020R		●	●	●										

For details of milling cutters, see page 155.

● : Stock ★ : 2 weeks delivery

● SNG

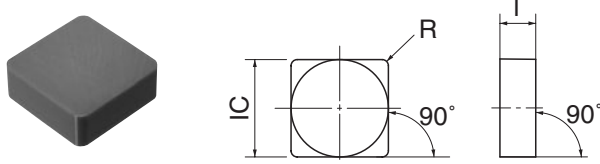

	IC	T		IC	T		IC	T
SNG32	3/8	1/8	SNG45	1/2	5/16	SNG63	3/4	3/16
SNG33	3/8	3/16	SNG54	5/8	1/4	SNG64	3/4	1/4
SNG43	1/2	3/16	SNG55	5/8	5/16	SNG65	3/4	5/16

Insert Order Number		ISO Catalog Number		R	Ceramics														
					Silicon-Nitride			SiAlON	Alumina		Alumina TiC			Whisker					
					SX1	SX6	SX8	SP2	SX5	SX9	HC1	HW2	HC2	HC6	HC7	ZC4	ZC7	WA1	
SNG 322	T0425	SNGN 090308	T01025	1/32	●		●						★	●					
	T0525		T01225	1/32									●						
324	T0425	090316	T01025	1/16			★				★	★							
	T0525		T01225	1/16									●						
332	T0425	090408	T01025	1/32									★						
333	T0425	090412	T01025	3/64									★						
432	T0220	120408	T00520	1/32					●	●									●
	T0420		T01020	1/32	●	●	●			●									●
	T0425		T01025	1/32	★		★			★		★	●				★		
	T0525		T01225	1/32						●		●				●			
	T0825		T02025	1/32	●		●	●		★									
433	T0220	120412	T00520	3/64					●	●									●
	T0420		T01020	3/64	●	●	●			●									●
	T0425		T01025	3/64			★			★		★	●				★		
	T0525		T01225	3/64								●				●			
	T0820		T02020	3/64		●													
	T0825		T02025	3/64	★		●	●		★									
	Z0825		Z02025	3/64													●		
434	T0220	120416	T00520	1/16					●	●									●
	T0420		T01020	1/16	●	●	●			●									●
	T0425		T01025	1/16						●		●	●				★		
	T0525		T01225	1/16								●				●			
	T0625		T01525	1/16								●							
	T0820		T02020	1/16		●													
	T0825		T02025	1/16	●		●	●		★									
436	T0625	120424	T01525	3/32									●						
	T0820		T02020	3/32			★			●									
438	S0825	120432	S02025	1/8									●						
	T0525		T01225	1/8									●						
	T0820		T02020	1/8						●									
	T0825		T02025	1/8	●		●	●											
452	T0220	120708	T00520	1/32															●
	T0825		T01025	1/32						★		★							
453	U1625	120712	U04025	3/64									●						
	T0220		T00520	3/64					●										●
	T0820		T02020	3/64						●									
	T0825		T02025	3/64			●	●					●						
454	U1625	120716	U04025	1/16						●		●							
	T0220		T00520	1/16					●		●								●
	T0820		T02020	1/16					●	●									
	T0825		T02025	1/16	●		●	●					●						
	Z0620		Z01520	1/16															●
543	T0825	150612	T02025	3/64			●												
544	T0825	150616	T02025	1/16			●												
554	T0820	150716	T02020	1/16															●
632	T0820	190408	T02020	1/32									●						
634	T0820	190416	T02020	1/16			●						●						
643	T0820	190612	T02020	3/64									●						
	T0825		T02025	3/64	●		●												

For details of toolholders, see pages 117, 118, 125, 129.
For details of milling cutters, see page 159.

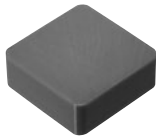
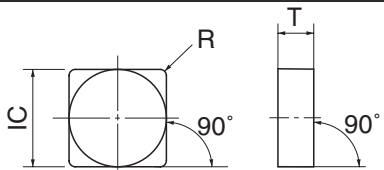
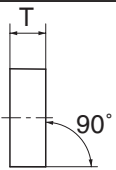

● : Stock ★ : 2 weeks delivery

			Ceramics																
			Silicon-Nitride		SiAlON		Alumina		Alumina TiC			Whisker							
Insert Order Number		ISO Catalog Number		R	SX1	SX6	SX8	SP2	SX5	SX9	HC1	HW2	HC2	HC6	HC7	ZC4	ZC7	WA1	
SNG 644 T0120	SNGN 190616 T00320		1/16						●										
T0220	T00520		1/16						●	●									●
T0420	T01020		1/16						●	●									
T0825	T02025		1/16				●				●			●					
Z0620	Z01520		1/16																●
654 T0825	190716 T02025		1/16											●					
656 T0120	190724 T00320		3/32						●										

● : Stock ★ : 2 weeks delivery

● **SNG-EN** with wiper for lead angle 75°

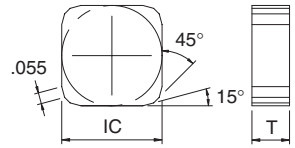
	IC	T
SNG43EN	1/2	3/16

			Ceramics															
			Silicon-Nitride		SiAlON		Alumina		Alumina TiC			Whisker						
Insert Order Number		ISO Catalog Number		R	SX1	SX6	SX8	SP2	SX5	SX9	HC1	HW2	HC2	HC6	HC7	ZC4	ZC7	WA1
SNG 43 EN TN	SNGN 1204 EN TN				●	●	●											

For details of milling cutters, see page 159.

● : Stock ★ : 2 weeks delivery

● SNGA

	IC	T	H
SNGA43	1/2	3/16	.203
SNGA54	5/8	1/4	.250
SNGA64	3/4	1/4	.312

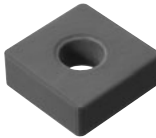
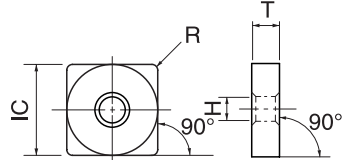
 		R	Ceramics													
			Silicon-Nitride			SiAlON	Alumina		Alumina TiC			Whisker				
			SX1	SX6	SX8	SP2	SX5	SX9	HC1	HW2	HC2	HC6	HC7	ZC4	ZC7	WA1
Insert Order Number	ISO Catalog Number															
SNGA 432 S0825	SNGA 120408 S02025	1/32												●		
T0220	T00520	1/32														●
T0420	T01020	1/32														●
T0525	T01225	1/32								●	●					
T0825	T02025	1/32	●		●											
Z0825	Z02025	1/32												●		
433 S0825	120412 S02025	3/64													●	
T0220	T00520	3/64						●								●
T0420	T01020	3/64						●								●
T0525	T01225	3/64								●	●					
T0820	T02020	3/64		●												
T0825	T02025	3/64	●		●	●										
Z0825	Z02025	3/64												●		
434 T0525	120416 T01225	1/16								●	●					
T0820	T02020	1/16		★												
T0825	T02025	1/16	●		●											
Z0825	Z02025	1/16												●		
543 T0220	150612 T00520	3/64						●								●
T0825	T02025	3/64	●		●	●										
544 T0220	150616 T00520	1/16						●								
T0820	T02020	1/16						●								
T0825	T02025	1/16	●			●										
643 T0825	190612 T02025	3/64	●		●	●										

For details of toolholders, see pages 125 and 129.

● : Stock ★ : 2 weeks delivery

● SNGA-WB with wiper for lead angle 75°

	IC	T	H
SNGA43_WB	1/2	3/16	.203

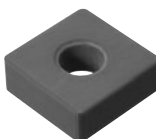
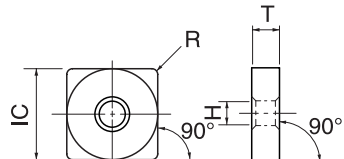
 		R	Ceramics													
			Silicon-Nitride			SiAlON	Alumina		Alumina TiC			Whisker				
			SX1	SX6	SX8	SP2	SX5	SX9	HC1	HW2	HC2	HC6	HC7	ZC4	ZC7	WA1
Insert Order Number	ISO Catalog Number															
SNGA 432 WB T0425	SNGA 120408 WB T01025	1/32	●													
433 WB T0425	120412 WB T01025	3/64	●													
434 WB T0425	120416 WB T01025	1/16	●													

For details of toolholders, see page 129.

● : Stock ★ : 2 weeks delivery

● **SNGA-WH** with wiper for higher feed in lead angle 85°

	IC	T	H
SNGA43_WH	1/2	3/16	.203

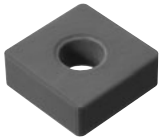
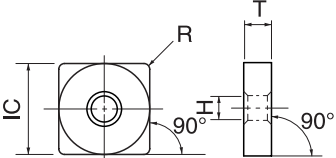
		R	Ceramics															
			Silicon-Nitride				SiAlON	Alumina		Alumina TiC			Whisker					
Insert Order Number		ISO Catalog Number			SX1	SX6	SX8	SP2	SX5	SX9	HC1	HW2	HC2	HC6	HC7	ZC4	ZC7	WA1
SNGA 432 WH T0425		SNGA 120408 WH T01025		1/32	●													
433 WH T0425		120412 WH T01025		3/64	●													
434 WH T0425		120416 WH T01025		1/16	●													

● : Stock ★ : 2 weeks delivery

● **SNGA-WHM** with wiper for slower feed in lead angle 85°

	IC	T	H
SNGA43_WHM	1/2	3/16	.203

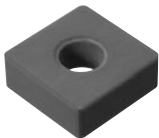
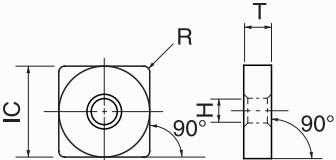
		R	Ceramics															
			Silicon-Nitride				SiAlON	Alumina		Alumina TiC			Whisker					
Insert Order Number		ISO Catalog Number			SX1	SX6	SX8	SP2	SX5	SX9	HC1	HW2	HC2	HC6	HC7	ZC4	ZC7	WA1
SNGA 432 WHM T0425		SNGA 120408 WHM T01025		1/32	●													
433 WHM T0425		120412 WHM T01025		3/64	●													

● : Stock ★ : 2 weeks delivery

● **SNGF** with chip-breaker

	IC	T
SNGF43	1/2	3/16

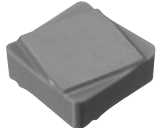
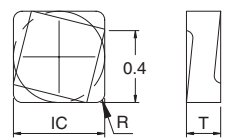
		R	Ceramics															
			Silicon-Nitride				SiAlON	Alumina		Alumina TiC			Whisker					
Insert Order Number		ISO Catalog Number			SX1	SX6	SX8	SP2	SX5	SX9	HC1	HW2	HC2	HC6	HC7	ZC4	ZC7	WA1
SNGF 433 TRCC413		SNGF 120412 TRCC413		3/64	●													

For details of milling cutters, see page 159.

● : Stock ★ : 2 weeks delivery

● **SNGX**

	IC	T
SNGX45	1/2	5/16
SNGX55	5/8	5/16

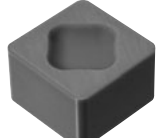
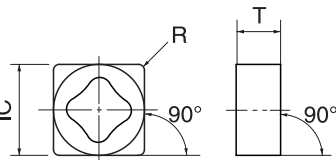
		R	Ceramics															
			Silicon-Nitride				SiAlON	Alumina		Alumina TiC			Whisker					
Insert Order Number		ISO Catalog Number			SX1	SX6	SX8	SP2	SX5	SX9	HC1	HW2	HC2	HC6	HC7	ZC4	ZC7	WA1
SNGX 452 T0220 DP5		SNGX 120708 T00520 DP5		1/32						●								
T0825 DP5		T02025 DP5		1/32	●													
453 T0220 DP5		120712 T00520 DP5		3/64						●								
T0820 DP5		T02020 DP5		3/64		●												
454 S0825 DP5		120716 S02025 DP5		1/16	●													
T0425 DP5		T01025 DP5		1/16	●													
T0820 DP5		T02020 DP5		1/16		●												
T0825 DP5		T02025 DP5		1/16	●													
553 T0220 DP5		150712 T00520 DP5		3/64					●	●								
554 T0825 DP5		150716 T02025 DP5		1/16	●													

For details of toolholders, see pages 117, 118 and 125.

● : Stock ★ : 2 weeks delivery

● SPG

	IC	T
SPG32	3/8	1/8
SPG42	1/2	1/8
SPG43	1/2	3/16
SPG63	3/4	3/16

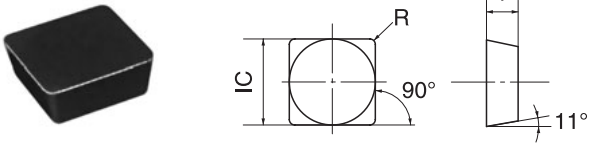
		R	Ceramics													
			Silicon-Nitride			SiAION	Alumina		Alumina TiC			Whisker				
			SX1	SX6	SX8	SP2	SX5	SX9	HC1	HW2	HC2	HC6	HC7	ZC4	ZC7	WA1
Insert Order Number		ISO Catalog Number														
SPG 322	T0425	SPGN 090308	T01025	1/32						★	●					
	T0525		T01225	1/32						●						
324	S0820	090316	S02020	1/16						●						
422	T0425	120308	T01025	1/32	●		●			●	●					
	T0525		T01225	1/32									●			
423	T0425	120312	T01025	3/64	●		●									
424	T0425	120316	T01025	1/16	●		●									
432	T0420	120408	T01020	1/32		●										
	T0425		T01025	1/32						●						
433	T0420	120412	T01020	3/64		●										
	T0425		T01025	3/64			●			★						
	T0825		T02025	3/64	●											
434	T0420	120416	T01020	1/16		●										
	T0425		T01025	1/16	●		●			★	●					
	T0820		T02020	1/16	●	●										
633	T0425	190412	T01025	3/64	●											
634	T0425	190416	T01025	1/16	●											
	T0825		T02025	1/16			●									
636	T0425	190424	T01025	3/32	●											
	T0825		T02025	3/32			●									

● : Stock ★ : 2 weeks delivery

● TBGE

	IC	T
TBGE52	5/32	1/16

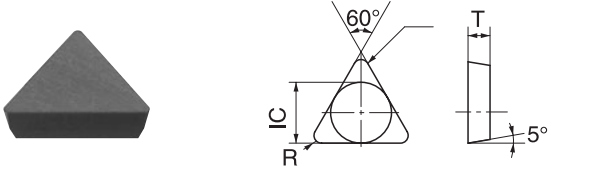
		R	Ceramics													
			Silicon-Nitride			SiAION	Alumina		Alumina TiC			Whisker				
			SX1	SX6	SX8	SP2	SX5	SX9	HC1	HW2	HC2	HC6	HC7	ZC4	ZC7	WA1
Insert Order Number		ISO Catalog Number														
TBGE 521	T0225	TBGE 060104	T00525	1/64												●
	522 T0225		060108 T00525	1/32												★

● : Stock ★ : 2 weeks delivery

	IC	T		IC	T		IC	T		IC	T
TNG22	1/4	1/8	TNG33	3/8	3/16	TNG43	1/2	3/16	TNG45	1/2	5/16
TNG32	3/8	1/8	TNG35	3/8	5/16	TNG44	1/2	1/4	TNG54	5/8	1/4

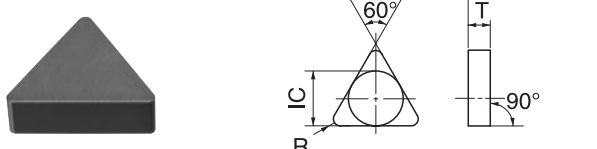
				R	Ceramics												
					Silicon-Nitride			SiAlON		Alumina		Alumina TiC			Whisker		
Insert Order Number	ISO Catalog Number				SX1	SX6	SX8	SP2	SX5	SX9	HC1	HW2	HC2	HC6	HC7	ZC4	ZC7
TNG 221	T0225	TNGN 110304	T00525	1/64								●					
222	T0225	110308	T00525	1/32								●	●				
321	T0425	160304	T01025	1/64								●					
322	T0425	160308	T01025	1/32								●	●				
	T0525		T01225	1/32											●		
	T0825		T02025	1/32								●					
331	T0425	160404	T01025	1/64								●					
332	T0420	160408	T01020	1/32													●
	T0425		T01025	1/32						★		★	●			★	
	T0525		T01225	1/32								●			●		
	T0820		T02020	1/32		★											
	T0825		T02025	1/32	★				★								
333	T0425	160412	T01025	3/64			●	●		★		●	●			★	
	T0420		T01020	3/64													●
	T0525		T01225	3/64											●		
	T0820		T02020	3/64		★						●					
	T0825		T02025	3/64	★		★		★								
334	T0425	160416	T01025	1/16			●			★	★	★					
	T0525		T01225	1/16								●			●		
	T0820		T02020	1/16		★											
	T0825		T02025	1/16	★			★	★								
335	T0425	160420	T01025	5/64	●					★		★					
	T0820		T02020	5/64		★											
	T0825		T02025	5/64	★												
352	T0825	160708	T02025	1/32								●					
353	T0825	160712	T02025	3/64								●					
431	T0425	220404	T01025	1/64								●					
432	T0220	220408	T00520	1/32					●	●							●
	T0420		T01020	1/32						●							●
	T0425		T01025	1/32									●				
	T0525		T01225	1/32								●					
	T0825		T02025	1/32	●			●									
	Z0825		Z02025	1/32											●		
433	T0220	220412	T00520	3/64					●								●
	T0425		T01025	3/64									●				
	T0630		T01530	3/64								●					
	T0825		T02025	3/64	●												
	Z0820		Z02020	3/64								●					
	Z0825		Z02025	3/64											●	●	
434	T0220	220416	T00520	1/16					●								●
	T0625		T01525	1/16								●					
	T0825		T02025	1/16	●		●	●									
438	T0825	220432	T02025	1/8	●												
452	T0220	220708	T00520	1/32					●								
	T0825		T02025	1/32								●					
453	T0220	220712	T00520	3/64					●								●
454	T0825	220716	T02025	1/16								●					
543	T0825	270612	T02025	3/64								●					
544	T0120	270616	T00320	1/16					●								
	T0220		T00520	1/16													●
	T0825		T02025	1/16								●					

For details of toolholders, see pages 126 and 127.

● : Stock ★ : 2 weeks delivery

● TNGA

	IC	T	H
TNGA32	3/8	1/8	.150
TNGA33	3/8	3/16	.150
TNGA43	1/2	3/16	.203
TNGA54	5/8	1/4	.250

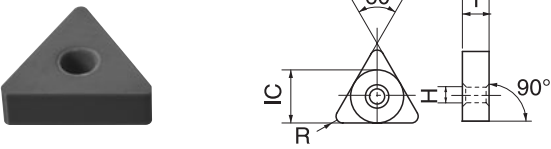
		Ceramics													
		Silicon-Nitride				SiAlON	Alumina		Alumina TiC			Whisker			
		SX1	SX6	SX8	SP2	SX5	SX9	HC1	HW2	HC2	HC6	HC7	ZC4	ZC7	WA1
Insert Order Number	ISO Catalog Number	R													
TNGA 321 T0425	TNGA 160304 T01025	1/64						●							
322 T0525	160308 T01225	1/32						●							
331 T0425	160404 T01025	1/64						●							
Z0825	Z02025	1/64										●			
332 S0825	160408 S02025	1/32											●		
T0425	T01025	1/32	●		●	●									
T0525	T01225	1/32						●	●		●				
T0820	T02020	1/32		★											
Z0825	Z02025	1/32										●			
333 S0825	160412 S02025	3/64												●	
T0425	T01025	3/64	●		●	●			★	★				★	
T0525	T01225	3/64							●						
T0820	T02020	3/64		★											
T0825	T02025	3/64	★				★								
Z0825	Z02025	3/64										●			
432 S0825	220408 S02025	1/32												●	
T0220	T00520	1/32													●
T0825	T02025	1/32	●		●	●			●						
433 T0825	220412 T02025	3/64	●		●	●			●						
Z0825	Z02025	3/64										●			
434 T0825	220416 T02025	1/16	●		●	●			●						
542 T0825	270608 T02025	1/32			●										
544 T0825	270616 T02025	1/16			●										

For details of toolholders, see pages 126 and 127.

● : Stock ★ : 2 weeks delivery

● TNGG with chip-breaker

	IC	T
TNGG33	3/8	1/16

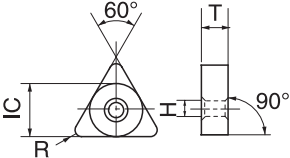
		R	Ceramics															
			Silicon-Nitride				SiAlON	Alumina		Alumina TiC			Whisker					
Insert Order Number		ISO Catalog Number			SX1	SX6	SX8	SP2	SX5	SX9	HC1	HW2	HC2	HC6	HC7	ZC4	ZC7	WA1
TNGG 332 Z0430 AG		TNGG 160408 Z01030 AG		1/32														●
333 Z0430 AG		160412 Z01030 AG		3/64														●

For details of toolholders, see pages 126 and 127.

● : Stock ★ : 2 weeks delivery

● TP

	IC	T
TP41	1/4	3/32
TP42	1/4	3/32

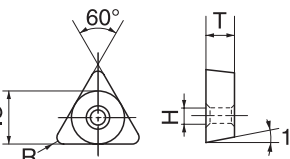
		R	Ceramics															
			Silicon-Nitride				SiAlON	Alumina		Alumina TiC			Whisker					
Insert Order Number		ISO Catalog Number			SX1	SX6	SX8	SP2	SX5	SX9	HC1	HW2	HC2	HC6	HC7	ZC4	ZC7	WA1
TP 41 T0225				1/64									●					
42 T0225				1/32									●					

● : Stock ★ : 2 weeks delivery

● TPG

	IC	T
TPG22	1/4	1/8
TPG32	3/8	1/8
TPG43	1/2	3/16

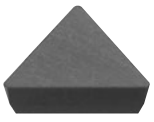
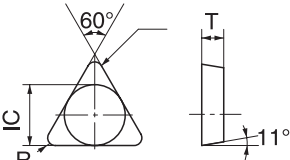
		R	Ceramics															
			Silicon-Nitride				SiAlON	Alumina		Alumina TiC			Whisker					
Insert Order Number		ISO Catalog Number			SX1	SX6	SX8	SP2	SX5	SX9	HC1	HW2	HC2	HC6	HC7	ZC4	ZC7	WA1
TPG 221 T0225		TPGN 110304 T00525		1/64									●					
T0525		T01225		1/64													●	
222 T0225		110308 T00525		1/32									●	●				
T0525		T01225		1/32													●	
T0825		T02025		1/32									●					
321 T0425		160304 T01025		1/64									●					★
322 T0220		160308 T00520		1/32					●									●
T0425		T01025		1/32	●		●	●			●		★	●				★
T0525		T01225		1/32									●					
323 T0220		160312 T00520		3/64					●									●
T0425		T01025		3/64							●		●					
T0525		T01225		3/64													●	
324 T0425		160316 T01025		1/16									●					
431 T0425		220404 T01025		1/64									●					
432 T0220		220408 T00520		1/32					●									
T0425		T01025		1/32	●		●						●	●				
T0525		T01225		1/32													●	
433 T0220		220412 T00520		3/64					●									
434 T0220		220416 T00520		1/16					●									
T0425		T01025		1/16									●					

● : Stock ★ : 2 weeks delivery

● TPGE

	IC	T
TPGE52	5/32	1/16
TPGE73	7/32	3/32

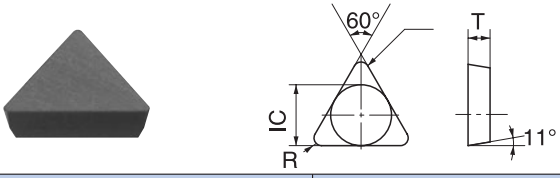
		R	Ceramics													
			Silicon-Nitride			SiAlON	Alumina		Alumina TiC			Whisker				
			SX1	SX6	SX8	SP2	SX5	SX9	HC1	HW2	HC2	HC6	HC7	ZC4	ZC7	WA1
Insert Order Number		ISO Catalog Number														
TPGE 521 T0225	TPGN 060104 T00525		1/64							●						
731 T0225	090204 T00525		1/64							●						
732 T0225	090208 T00525		1/32							●						

● : Stock ★ : 2 weeks delivery

● TSN

	IC	T
TSN 45	1/2	5/16
TSN 46	1/2	.394
TSN 55	5/8	5/16

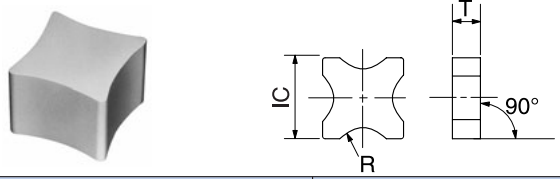
		R	Ceramics													
			Silicon-Nitride			SiAlON	Alumina		Alumina TiC			Whisker				
			SX1	SX6	SX8	SP2	SX5	SX9	CX3	HC1	HW2	HC2	HC6	HC7	ZC4	ZC7
Insert Order Number		ISO Catalog Number														
TSN 45-20 T0625	TSN 1207-20 T01525		.785							●						
45-25 T0625	1207-25 T01525		.985							●						
45-30 T0625	1207-30 T01525		1.180							●						
45-40 T0625	1207-40 T01525		1.575							●						
46A-12 EF	1210A-12 EF		.475							●						
46A-15 EF	1210A-15 EF		.590							●						
46A-20 EF	1210A-20 EF		.785							●						
46A-25 EF	1210A-25 EF		.985							●						
46A-30 EF	1210A-30 EF		1.180							●						
46A-40 EF	1210A-40 EF		1.575							●						
46A-50 EF	1210A-50 EF		1.970							●						
46A-70 EF	1210A-70 EF		2.760							●						
55-20 T0625	1507-20 T01525		.785							●						
55-25 T0625	1507-25 T01525		.985							●						
55-30 T0625	1507-30 T01525		1.180							●						
55-40 T0625	1507-40 T01525		1.575							●						
55-50 T0625	1507-50 T01525		1.970							●						

For details of toolholders, see page 176.

● : Stock ★ : 2 weeks delivery

VDB

	W	S	T		W	S	T		W	S	T
VDB125A	.125	.106	.250	VDB218A	.218	.144	.250	VDB312B	.312	.202	.337
VDB156A	.156	.106	.250	VDB250B	.250	.202	.337	VDB344B	.344	.275	.337
VDB188A	.188	.144	.250	VDB281B	.281	.202	.337	VDB375B	.375	.275	.337

		Ceramics														
		Silicon-Nitride		SiAlON	Alumina		Alumina TiC			Whisker						
		SX1	SX6	SX8	SP2	SX5	SX9	HC1	HW2	HC2	HC6	HC7	ZC4	ZC7	WA1	
		R														
Insert Order Number	ISO Catalog Number															
VDB 125 A015 T0225	VDB 125 A015 T00525	.015								●						
156 A015 T0225	156 A015 T00525	.015								●						
188 A015 T0225	188 A015 T00525	.015								●						
218 A015 T0225	218 A015 T00525	.015								●						
250 B015 T0225	250 B015 T00525	.015								●						
B031 T0220	B031 T00520	.031				●	●								●	
B062 T0220	B062 T00520	.062					●									
281 B015 T0225	281 B015 T00525	.015								●						
312 B015 T0225	312 B015 T00525	.015								●						
B031 EX001	B031 EX0001	.031													●	
T0220	T00520	.031				●										
B062 EX001	B062 EX0001	.062													●	
T0220	T00520	.062				●										
344 B015 T0225	344 B015 T00525	.015								●						
375 B015 T0225	375 B015 T00525	.015								●						
B031 EX001	B031 EX0001	.031													●	
T0220	T00520	.031				●										
B046 E02	B046 E004	.046					●									
T0220	T00520	.046					●									
B062 E02	B062 E004	.062					●									
EX001	EX0001	.062													●	
T0220	T00520	.062				●	●									

For details of toolholders, see pages 136 - 138.

● : Stock ★ : 2 weeks delivery

VDB-R

	W	S	T		W	S	T		W	S	T
VDB125RA	.125	.106	.250	VDB218RA	.218	.144	.250	VDB312RB	.312	.202	.337
VDB156RA	.156	.106	.250	VDB250RB	.250	.202	.337	VDB344RB	.344	.275	.337
VDB188RA	.188	.144	.250	VDB281RB	.281	.202	.337	VDB375RB	.375	.275	.337

		Ceramics														
		Silicon-Nitride		SiAlON	Alumina		Alumina TiC			Whisker						
		SX1	SX6	SX8	SP2	SX5	SX9	HC1	HW2	HC2	HC6	HC7	ZC4	ZC7	WA1	
		R														
Insert Order Number	ISO Catalog Number															
VDB 125 RA T0225	VDB 125 RA T00525	.063								●						
156 RA T0225	156 RA T00525	.078								●						
188 RA T0225	188 RA T00525	.094								●						
218 RA T0225	218 RA T00525	.109								●						
250 RB T0220	250 RB T00520	.125				●									●	
T0225	T00525	.125								●						
281 RB T0225	281 RB T00525	.141								●						
312 RB T0225	312 RB T00525	.156								●						
344 RB T0225	344 RB T00525	.172								●						
375 RB T0225	375 RB T00525	.188								●						

For details of toolholders, see pages 136 - 138.

● : Stock ★ : 2 weeks delivery

● VGK

	W	T	L
VGK8250	.250	.328	1
VGK8312	.312	.328	1
VGK8375	.375	.328	1

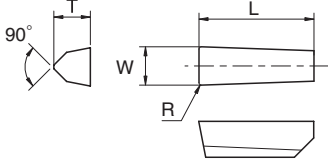
		R	Ceramics															
			Silicon-Nitride				SiAlON		Alumina		Alumina TiC			Whisker				
Insert Order Number		ISO Catalog Number			SX1	SX6	SX8	SP2	SX5	SX9	HC1	HW2	HC2	HC6	HC7	ZC4	ZC7	WA1
VGK 82502 T0220	VGK 82502 T00520	.031							●									
83122 T0220	83122 T00520	.031							●									
83124 T0220	83124 T00520	.062							●									
83752 T0220	83752 T00520	.031							●									
83754 T0220	83754 T00520	.062							●									

● : Stock ★ : 2 weeks delivery

● VGK-R

	W	T	L
VGK8312R	.312	.328	1

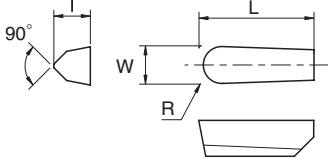
		R	Ceramics															
			Silicon-Nitride				SiAlON		Alumina		Alumina TiC			Whisker				
Insert Order Number		ISO Catalog Number			SX1	SX6	SX8	SP2	SX5	SX9	HC1	HW2	HC2	HC6	HC7	ZC4	ZC7	WA1
VGK 8312R T0220	VGK 8312R T00520	.156							●									

● : Stock ★ : 2 weeks delivery

● **VGW**

	W	T	L		W	T	L
VGW4125	.125	.187	.500	VGW6281	.281	.250	.750
VGW4156	.156	.187	.500	VGW8312	.312	.337	1
VGW4187	.187	.187	.500	VGW8375	.375	.337	1
VGW6250	.250	.250	.750				

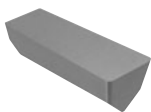
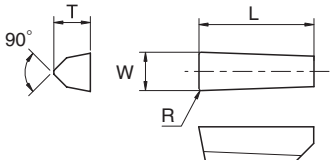
 		R	Ceramics													
			Silicon-Nitride				SiAlON	Alumina		Alumina TiC			Whisker			
			SX1	SX6	SX8	SP2	SX5	SX9	HC1	HW2	HC2	HC6	HC7	ZC4	ZC7	WA1
Insert Order Number		ISO Catalog Number														
VGW 41251 EX001	VGW 41251 EX0001	.015														●
41252 EX001	41252 EX0001	.031														●
41561 EX001	41561 EX0001	.015														●
41562 EX001	41562 EX0001	.031														●
41871 EX001	41871 EX0001	.015														●
T0220	T00520	.015			●											
41872 EX001	41872 EX0001	.031														●
T0220	T00520	.031			●											
62501 T0220	62501 T00520	.015														●
T0420	T01020	.015														●
Z0220	Z00520	.015														●
Z0420	Z01020	.015														●
62502 EX001	62502 EX0001	.031														●
T0220	T00520	.031			●											
62503 EX001	62503 EX0001	.046														●
T0220	T00520	.046			●											
62814 EX001	62814 EX0001	.062														●
83122 EX001	83122 EX0001	.031														●
83124 T0220	83124 T00520	.062			●											
83752 EX001	83752 EX0001	.031														●
T0220	T00520	.031			●											
83754 EX001	83754 EX0001	.062														●
T0220	T00520	.062			●											●

For details of toolholders, see pages 132 - 134.

● : Stock ★ : 2 weeks delivery

● VGW-R

	W	T	L		W	T	L
VGW4125R	.125	.187	.500	VGW6250R	.250	.250	.750
VGW4156R	.156	.187	.500	VGW8312R	.312	.337	1
VGW4187R	.187	.187	.500	VGW8375R	.375	.337	1
VGW6218R	.218	.250	.750				

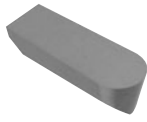
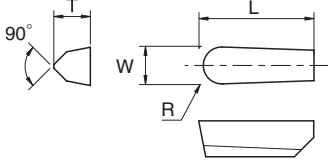
 		R	Ceramics												
			Silicon-Nitride				SiAlON	Alumina		Alumina TiC			Whisker		
			SX1	SX6	SX8	SP2	SX5	SX9	HC1	HW2	HC2	HC6	HC7	ZC4	ZC7
Insert Order Number	ISO Catalog Number														
VGW 4125R EX001	4125R EX0001	.063												●	
4156R EX001	4156R EX0001	.078												●	
4187R EX001	4187R EX0001	.094												●	
T0220	T00520	.094				●									
6218R EX001	6218R EX0001	.109												●	
6250R EX001	6250R EX0001	.125												●	
T0220	T00520	.125				●									
8312R EX001	8312R EX0001	.156												●	
T0220	T00520	.156				●									
8375R EX001	8375R EX0001	.188												●	
T0220	T00520	.188				●									

For details of toolholders, see pages 132 - 134.

● : Stock ★ : 2 weeks delivery

● VNG

	IC	T
VNG33	3/8	3/16
VNG43	1/2	3/16

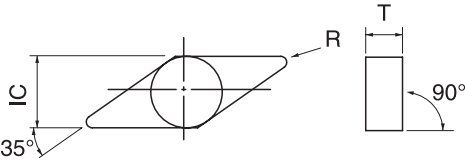
 		R	Ceramics												
			Silicon-Nitride				SiAlON	Alumina		Alumina TiC			Whisker		
			SX1	SX6	SX8	SP2	SX5	SX9	HC1	HW2	HC2	HC6	HC7	ZC4	ZC7
Insert Order Number	ISO Catalog Number														
VNG 331 T0425	VNGN 160404 T01025	1/64							●	★					
332 T0425	160408 T01025	1/32							●						

● : Stock ★ : 2 weeks delivery

● VNGA

	IC	T	H
VNGA33	3/8	3/16	.150
VNGA43	1/2	3/16	.203

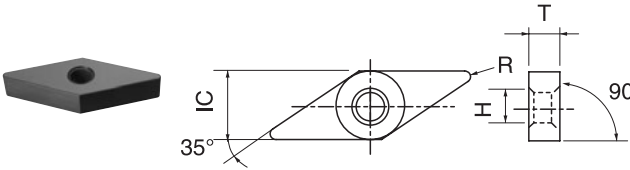

Insert Order Number		ISO Catalog Number		R	Ceramics												
					Silicon-Nitride		SiAlON	Alumina		Alumina TiC			Whisker				
					SX1	SX6	SX8	SP2	SX5	SX9	HC1	HW2	HC2	HC6	HC7	ZC4	ZC7
VNGA 331	S0825	VNGA 160404	S02025	1/64													●
	T0220		T00520	1/64				●									
	T0425		T01025	1/64							●	★				★	
	T0525		T01225	1/64								●			●		
	Z0825		Z02025	1/64											●		
332	S0825	160408	S02025	1/32												●	
	T0220		T00520	1/32				●									●
	T0420		T01020	1/32		★											
	T0425		T01025	1/32	●						●	★				★	
	T0525		T01225	1/32								●			●		
	Z0825		Z02025	1/32											●		
333	S0825	60412	S02025	3/64												●	
	T0220	160412	T00520	3/64													●
	T0420		T01020	3/64		★											
	T0425		T01025	3/64	●						●				●	★	
	T0525		T01225	3/64											●		
	T0825		T02025	3/64				★									
	Z0825		Z02025	3/64											●		
431	T0425	220404	T01025	1/64								●					
436	T0420	220424	T01020	3/32													●

For details of toolholders, see pages 123 and 124.

● : Stock ★ : 2 weeks delivery

● WNGA

	IC	T	H
WNGA33	3/8	3/16	.150
WNGA43	1/2	3/16	.203
WNGA54	5/8	1/4	.250

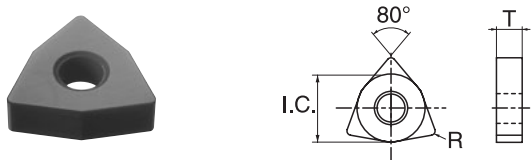

Insert Order Number		ISO Catalog Number		R	Ceramics												
					Silicon-Nitride		SiAlON	Alumina		Alumina TiC			Whisker				
					SX1	SX6	SX8	SP2	SX5	SX9	HC1	HW2	HC2	HC6	HC7	ZC4	ZC7
WNGA 331	T0525	WNGA 060404	T01225	1/64													●
332	T0525	060408	T01225	1/32													●
333	T0525	060412	T01225	3/64													●
431	T0220	080404	T00520	1/64													●
	Z0825		Z02025	1/64												●	
432	T0220	080408	T00520	1/32					●	●							●
	T0525		T01225	1/32												●	
	T0820		T02020	1/32		★						●					
	T0825		T02025	1/32	●		●	●									
	Z0825		Z02025	1/32												●	
433	T0220	080412	T00520	3/64					●	●							●
	T0525		T01225	3/64												●	
	T0820		T02020	3/64		★						●					
	T0825		T02025	3/64	●		●	●									
434	T0420	080416	T01020	1/16						●							
	T0820		T02020	1/16		★											
	T0825		T02025	1/16	●		●										

For details of toolholders, see pages 126 and 129.

● : Stock ★ : 2 weeks delivery

